

Delivering leading edge, innovative power solutions for more than **30** years....

Model:GTM961800PWWWVV.V-T3

September 29, 2022

180W AC DC Adapter, Desktop Power Supply, for ICT/ITE, Medical, and Household use, 3 Prong Input (C14)

Information

Model Number	GTM961800PWWWVV.V-T3
Description	180 W, DoE Level VI & CoC Tier 2 Efficiency, Three Prong (C14) Inlet, Desktop Adapter, Ac-Dc Power Supply

Model Picture



Agency Documents	http://www.globtek.info/certs/GTM961800P/
CE EC-Declaration	https://www.globtek.com/pdf/ec_declaration/a000c00000Old6SEAR
RoHS/RoHS2 Declaration	https://www.globtek.com/pdf/rohs_cert/a000c00000Old6SEAR
REACH Declaration	https://www.globtek.com/pdf/iso_certificates/REACH.pdf
Conflict Minerals Declaration	https://www.globtek.com/pdf/conflict-minerals.pdf

Delivering leading edge, innovative power solutions for more than **30** years....

Model:GTM961800PWWWVV.V-T3

September 29, 2022

MODEL PARAMETERS

Type	Desktop/External
Technology	Regulated Switchmode AC-DC Power Supply AC Adaptor
Category	Medical/ICT/ITE/Household use Power Supply
Input Voltage	100-240V~, 50-60Hz
I/P Amps (A)	2.2A
Wattage (W)	180.0
Vout Range (V)	12-54
Efficiency Level	USA DOE Level VI / Eco-design Directive 2009/125/EC, (EU) 2019/1782
Ingress Protection	IP41
Size (mm)	176.5*74*40

Delivering leading edge, innovative power solutions for more than 30 years....

Model:GTM961800PWWWVV.V-T3

September 29, 2022

ENCLOSURE

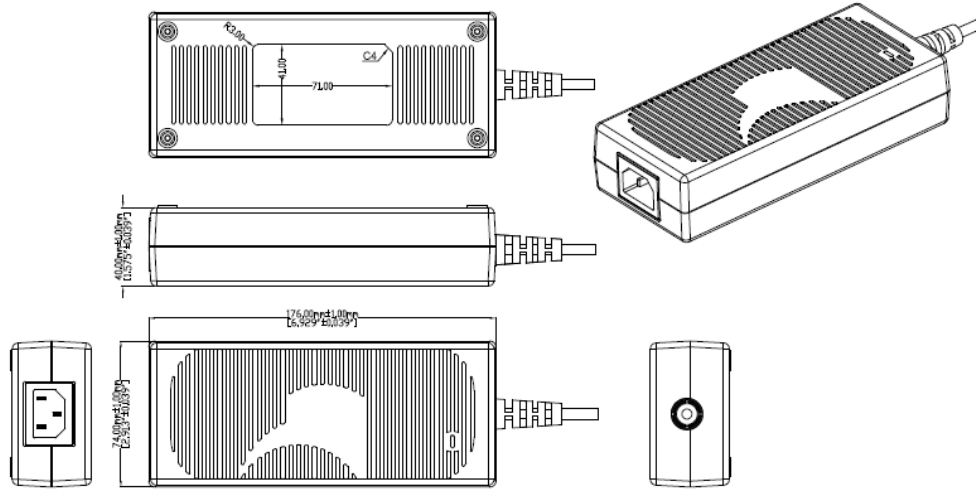

Delivering leading edge, innovative power solutions for more than 30 years....

Model:GTM961800PWWWVV.V-T3

September 29, 2022

RATING TABLE

Model Number	Voltage	Amps(A)	Watts(W)	RFQ
GTM961800P16012-T3	12 V	13.33	159.96	RFQ
GTM961800P16012-T3-CF	12 V	13.33	159.96	RFQ
GTM961800P16012-T3-CF	12.0 V	13.33	159.96	RFQ
GTM961800P10812-T3	12 V	9	108.00	RFQ
GTM961800P16013.5-T3	13.5 V	11.85	159.98	RFQ
GTM961800P17015-T3-CF	15 V	11.33	169.95	RFQ
GTM961800P17015-T3	15 V	11.33	169.95	RFQ
GTM961800P17018-T3	18 V	9.44	169.92	RFQ
GTM961800P17018-T3-CF	18 V	9.44	169.92	RFQ
GTM961800P18020-T3	20 V	9	180.00	RFQ
GTM961800P18020-T3-CF	20 V	9	180.00	RFQ
GTM961800P18024-T3	24 V	7.5	180.00	RFQ
GTM961800P18024-T3-CF	24 V	7.5	180.00	RFQ
GTM961800P17024-T3	24 V	7.08	169.92	RFQ
GTM961800P18028-T3	28 V	6.42	179.76	RFQ
GTM961800P18028-T3-CF	28 V	6.42	179.76	RFQ
GTM961800P18030-T3-CF	30 V	6	180.00	RFQ
GTM961800P18030-T3	30 V	6	180.00	RFQ
GTM961800P18036-T3	36 V	5	180.00	RFQ
GTM961800P18036-T3-CF	36 V	5	180.00	RFQ
GTM961800P18040-T3	40 V	4.5	180.00	RFQ
GTM961800P18048-T3-CF	48 V	3.75	180.00	RFQ
GTM961800P18048-T3	48 V	3.75	180.00	RFQ
GTM961800P18054-T3	54 V	3.333	179.98	RFQ
GTM961800P18054-T3-CF	54 V	3.333	179.98	RFQ

PROPRIETARY INFORMATION

PROPRIETARY OF GLOBTEK, INC. ANY REPRODUCTION, DISCLOSURE OR USE OF THIS DRAWING, IN WHOLE OR IN PART, IS HEREBY PROHIBITED EXCEPT AS SPECIFIED IN WRITING BY GLOBTEK, INC.

Model:GTM961800PWWWVV.V-T3

September 29, 2022

SPECIFICATIONS

Input

Input Voltage:	Specified: 90-264VAC, Nameplate: 100-240VAC 100% rated load current for 90-264VAC 90% rated load current for 85-264VAC
Input Frequency:	Specified: 47-63Hz, Nameplate: 50-60Hz
Power Factor:	0.90 (min.) @ 230VAC, 0.97 (min.) @ 115VAC
No Load Input Power:	<150mW @ 230VAC (EU CoC Tier 2 compliant)
Inrush Current:	30A/60A max. (cold start @ 115V/230VAC)
Efficiency:	DoE Level VI and EU CoC Tier 2 compliant

Output

Turn-on Delay:	1 second typ. @ 115VAC and full load
Output Regulation:	± 4% (measured at output connector)
Line Regulation:	± 0.5% typ. (measured at output connector, full load)
Ripple:	1% or 200mV, whichever is greater (using a 47µF low-ESR cap + 0.1µF ceramic capacitor, measured @ 20MHz BW, at output connector)
Turn-On Overshoot:	5% max.
Transient Response:	5% max. deviation, 1ms recovery time (with 25% to 50% load step)
Hold-up Time:	20ms min.
Switching Frequency:	25 - 125KHz, depending on model and load condition
Power Indicator:	Green LED

Protections

Input Protection:	MOV transient suppressor, dual input line fusing
Over-Current Protection:	105 - 140% of rated output current, auto-restart
Short-Circuit Protection:	Auto-restart
Over-Voltage Protection:	110 - 135% (60V max. for output voltage ≥ 45V), latched off, cycle AC to reset

Environmental

MTBF:	1,500,000 hours @ 25°C ambient, full load (Telcordia SR-332, Issue 3)
Operating Temperature:	-10°C to 40°C (full load)
Storage Temperature:	-30°C to 80°C
Humidity:	0% to 95% relative humidity, non-condensing
Altitude:	5000m
Cooling:	Convection

Delivering leading edge, innovative power solutions for more than 30 years....

Model:GTM961800PWWWVV.V-T3

September 29, 2022

RoHS:	Complies with EU 2011/65/EU and China SJ/T 11363-2006
Note 1:	Regarding operating temperature a. See below de-rating table for output power capability at alternate temperature b. Extended low-end temperature range available as a custom option

Safety

Dielectric Withstand Voltage:	4000VAC or 5656VDC from input to output 3000VAC or 4242VDC from input to earth (Class I models only)
Touch Current:	Standard models (No suffix): Class I: 20µA max. Class II: 70µA max. Class II with Functional Earth (F2): 20µA max. Low-leakage models (-CF suffix): Class II with Functional Earth (F2): 10µA max.
Note 2:	Standard models are designed for use in Type-B/BF medical applications. Low-leakage models are designed for use in Type-CF medical applications. (See IEC60601-1, Clause 16.6.1)
Earth Leakage Current	Class I: 300µA max. Class II: N/A
Means of Protection:	2 x MOPP
Output Isolation Options:	Class I: C6 or C14 inlet (output negative tied to Earth contact) Class II: C8 or C18 inlet Class II FE: C6 or C14 inlet (output isolated from Earth contact) Review isolation options by reading our white paper PSU Isolation and Identity .
Earth Continuity Test:	< 0.1Ω between earth pin (on AC inlet) and PCB termination point (Class I models only)
Compliant Standards:	See listing at end of this datasheet for specific standards

EMC

Applicable Standards:	Medical: EN60601-1-2, 4th edition Emissions: EN55032, EN61000-6-3, EN61000-6-4, CISPR11, CISPR22 Immunity: EN55024, EN61000-6-1, EN61000-6-2
Conducted Emissions:	Class B, FCC Part 15, Class B (with resistive load)
Radiated Emissions:	Class B, FCC Part 15, Class B (with resistive load)
Harmonic Current Voltage Distortion:	EN61000-3-2, Class A
Voltage Fluctuations/Flicker:	EN61000-3-3
Electrostatic Discharge (ESD) Immunity:	EN61000-4-2, 10KV contact discharge, 18KV air discharge
Radiated RF Immunity:	EN61000-4-3, 10V/m 80-2700MHz, 80% 1KHz AM
EFT/Burst Immunity:	EN61000-4-4, 4KV/100kHz.
Line Surge Immunity:	EN61000-4-5, 2KV differential, 4KV common-mode
Conducted RF Immunity:	EN61000-4-6, 3VRMS, 80% 1KHz AM
Power Frequency Magnetic Field Immunity:	EN61000-4-8, 3A/m

Delivering leading edge, innovative power solutions for more than **30** years....

Model:GTM961800PWWWVV.V-T3

September 29, 2022

Voltage Dip Immunity:	EN61000-4-11
-----------------------	--------------

Enclosure

Material/Construction:	High impact plastic, 94V0 polycarbonate, non-vented
Size:	176.5 * 74.0 * 40.0mm (±1.0mm)
AC Input Mechanical Options:	Desktop: C6, C7, C14, or C18 inlet
Markings:	Label and/or pad printed and/or laser-etched into case

Special Options

1. Custom cordsets, cord types, and connector types
2. Custom markings
3. Custom housing and cordset colors
4. Constant current/constant voltage (CC/CV) output behavior, with compliance voltage between (75% * Vout) and (100% * Vout)
5. Short term output surge power capability, for motor applications and short term intermittent high power applications. (Up to 300W for 1 second.)
6. IEC61000-3-2 Class C line harmonics for LED lighting applications
7. "Back EMF" upgrade, for motor loads and other high inductance applications with reverse energy flow requirements
8. Reduced touch/leakage current for IEC60601-1 Type-CF applications. (Available in models with -CF suffix.)
9. High reliability PCB laminate with plated through-holes for IPC610 Class 2 compliance
10. Tightened output voltage tolerance
11. Reduced output ripple level
12. Reduced output power rating
13. Improved ingress protection (IP) rating

Output Connectors

- Several output connector options are available with various output current ratings. GlobTek can supply 10A rated 2.1mm and 2.5mm style DC Power Jacks, to complement our 10A output rated 2.1mm and 2.5mm DC power plugs used on our output cordsets.
- Please visit our real-time listing of mating connector product offering:
<https://en.globtek.com/news/high-current-coaxial-barrel-plug-jacks-for-high-wattage-power-supplies>

Delivering leading edge, innovative power solutions for more than 30 years....

Model:GTM961800PWWWVV.V-T3

September 29, 2022

DERATING CURVE

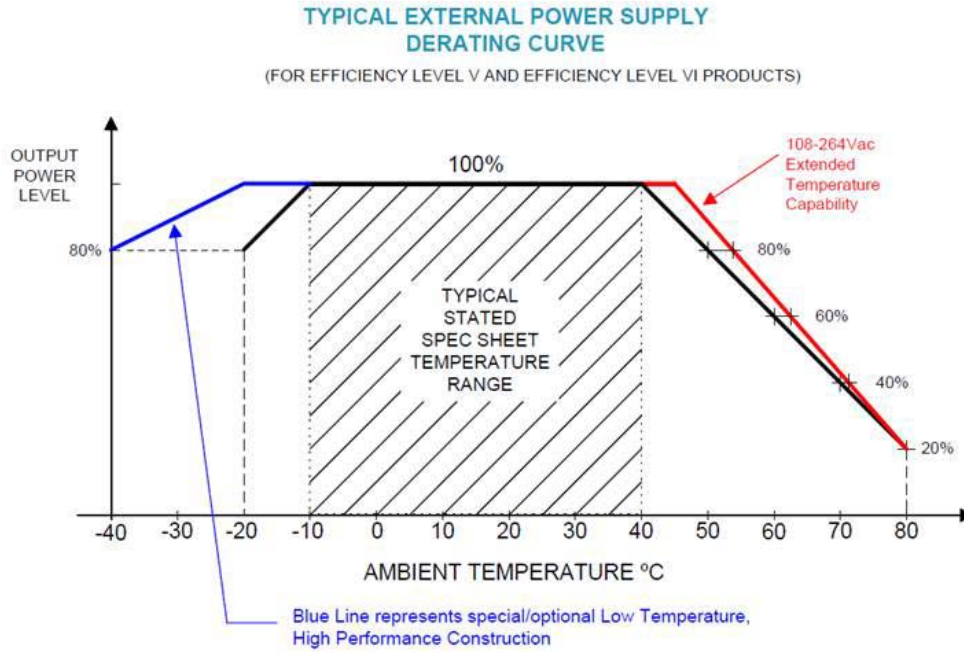

Delivering leading edge, innovative power solutions for more than 30 years....

Model:GTM961800PWWWVV.V-T3

September 29, 2022

INPUT CONFIGURATION

 Description IEC 60320/C14 AC Inlet Connector, Class I, Earth Ground

Mates with IEC 60320/C13 Plug

Optional Locking IEC60320 Receptacle and cord option available on some models by request.:

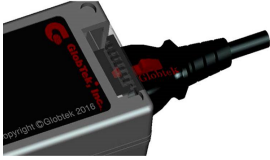
[Standard International IEC 320/C13 Cordsets](#)

Below are standard cordsets which are "not included" (unless stated above); these can be purchased separately or packaged with the power supply. Contact your Sales Engineer if the style required is not shown below. Many more available in different lengths, colors or cable material.

Stock Power Supply Cords

Part Number/ Link	Country	Plug	Termination	Length (mm)	Length (Ft)
3021457F701(R)	N. American (Type B)	NEMA 5-15P	IEC 320/C13	2150	7
1191068F0701(R)	N. American (Type B)	NEMA 5-15P Hospital	IEC 320/C13	2459	8
2194272M5701-T(R)	Argentina (Type I)	IRAM 2073	IEC 320/C13	2500	8
5502022M5701A(R)	Australian (Type I)	AS3112 / 3 PRONG	IEC 320/C13	2500	8
204B4272M5701(R)	Brazil (Type N)	BRAZIL	IEC 320/C13	2500	8
6023602M5701(R)	China (Type I)	CCC GR2099	IEC 320/C13	2500	8
G8014272M5701(R)	Danish (Type K)	AFSNIT SECTION 107-2-D1	IEC 320/C13	2500	8
			IEC		

Delivering leading edge, innovative power solutions for more than 30 years....

Model:GTM961800PWWWVV.V-T3

September 29, 2022

23144272M5701-T(R)	Europe (Type E)	CEE 7/7	320/C13	2500	8
23134272M5701EUKR(R)	Europe/Korea Combo (Type E)	CEE 7/7 / KSC8305	IEC 320/C13	2500	8
205IN4272M5701(R)	India (Type D)	India IS 1293 (also known as IA16A3 or BS546)	IEC 320/C13	2500	8
208IN4272M5701(R)	India (Type M)	India IS 1293 (also known as IA16A3 or BS546)	IEC320/C13	2500	8
377C4272M5701(R)	Israel (Type H)	ISL 377C	IEC 320/C13	2500	8
23024272M5701(R)	Italy (Type L)	CEI 23-16/VII	IEC 320/C13	2500	8
3003339F701(R) [3x1.25mm2]	Japan (Type B)	JIS 8303 / 3 PINS	IEC 320/C13	2500	8
3003068F2701-HK(R) [3 x 2.0mm2]					
302J115J6F0701J(R)	North America / Japan (Type B – 12A)	NEMA 5-15P (cULus approved), Japan JIS C 8303 (PSE Approved)	IEC 320/C13	1830	6
302J104J6F0701J(R)	North America / Japan (Type B – 15A)	NEMA 5-15P (cULus approved), Japan JIS C 8303 (PSE Approved)	IEC 320/C13	1830	6
302JT104J9F0701JT(R)	North America / Japan / Taiwan (Type B – 15A)	NEMA 5-15P (cULus approved), Japan JIS C 8303 (PSE Approved), Taiwan CNS 6797 (BSMI Approved)	IEC 320/C13	2800	9
2313K3432M5701(R)	Korea (Type F)	KS C 8305	IEC 320/C13	2500	8
5804272M5701(R)	Russia (Type F)	GOST 7396	IEC 320/C13	2500	8
2084272M5701(R)	South Africa (Type M)	South Africa SABS164-1 (16A type)	IEC 320/C13	2500	8
23214272M5701(R)	Switzerland (Type J)	SEV 1011	IEC 320/C13	2500	8
3003322M5701(R)	Taiwan (Type B)	BSMI	IEC 320/C13	2500	8
6363762M5701(R)	Thailand (Type O)	TIS 166-2549	IEC 320/C13	2500	8
PZ0800100-2M5BK13H(R)	UK, Hong Kong, Singapore, Gulf States (Type G)	BS 1363A	IEC 320/C13	2500	8
7055002M5701A(R)	International	IEC 320 C14-C13	IEC 320/C13	2500	8

Delivering leading edge, innovative power solutions for more than 30 years....

Model:GTM961800PWWWVV.V-T3

September 29, 2022

OUTPUT CONFIGURATION

Common output connector options:

 L Type (Coaxial
5.5x2.5mm plug)

 C Type (Coaxial
5.5x2.1mm plug)

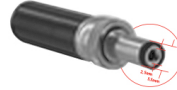
 K Type (Coaxial
3.5x1.3mm plug)

 LL Type (5.5x2.5mm
Locking 760k type)

 CL Type (5.5x2.1mm
Locking S761k type)

 ML2 Type (Molex
housing 43025-0200)

 YL3 Type
(KPPX-3P)

YL4 Type (KPPX-4P)

 EJ1/2/3/4/5 (EIAJ
RC-5320A type
connectors)

 MSB Type (Micro
USB)

 USBC Type (USB
Type C)

 Inquire for custom
design

 For a comprehensive list of options, [click here](#)





Contact GlobTek for your specific requirements or custom solutions.

Delivering leading edge, innovative power solutions for more than 30 years....

Model:GTM961800PWWWVV.V-T3

September 29, 2022







Approvals

Logo	Description
	Taiwan BSMI GTM961200P-T3(A) R32282 GTM961800P-12,15,18,19,24,48 and 54V http://www.bsmi.gov.tw/wSite/ct?xItem=4072&ctNode=816
No Logo Applicable	IEC 60601-1-11:2015
No Logo Applicable	IEC 60601-1: 2005 + C1 + C2 + A1
No Logo Applicable	CB for 60335-1:2010/COR1:2010/COR2:2010 /AMD1:2013/COR1:2014/AMD2:2016/COR1:2016
No Logo Applicable	IEC 60950-1:2005 (Second Edition) + Am 1:2009 + Am 2:2010
No Logo Applicable	CB for IEC 62368-1:2014 (Second Edition)
	CCC Altitude up to 5000 m GB17625.1-2012, GB4943.1-2011, GB/T9254-2008
	CE Certification
	Audio/Video, Information And Communication Technology Requirements [UL 62368-1:2014 Ed.2] Audio/Video, Information And Communication Technology Requirements [CSA C22.2#62368-1:2014 Ed.2]
	cETLus-Cert-4007497 ANSI/AAMI ES60601-1:2005 with A

Delivering leading edge, innovative power solutions for more than 30 years....

Model:GTM961800PWWWVV.V-T3

September 29, 2022

	2010 and CAN/CSA-C22.2 No. 60601-1 2008 with COR 2: HA60601-1-11 Ed:1
	cETLus-Cert-60950-1 4007497 Listed
	CHINA SJ/T 11364-2014, China RoHS Chart: http://en.globtek.com
Conforms to AAMI STD.ES60601-1,IEC 60601-1-11 Certified to CAN/CSA STD.C22.2 NO.60601-1	Conforms to AAMI STD.ES60601-1,IEC 60601-1-11 Certified to CAN/CSA STD.C22.2 NO.60601-1
Conforms to UL STD. 60950-1 Certified to CSA STD C22.2 NO.60950-1	Conforms to UL STD. 60950-1 Certified to CSA STD C22.2 NO.60950-1
Conforms to UL STD. 62368-1 Certified to CSA STD C22.2 NO.62368-1	Conforms to UL STD. 62368-1 Certified to CSA STD C22.2 NO.62368-1
	Declaration ДС № EAЭС N RU Д-US.KA01.B.10453_19 C Belarus and Kazakhstan http://www.globtek.com/redirect/?loc=gost-certificate-eac-c
No Logo	Greenhouse and Energy Minimum Standards (GEMS) for GTM961800P16012-T3(A) GTM961600P16012-T3(A)
No Logo	Greenhouse and Energy Minimum Standards (GEMS) for GTM96180-1817.9-5.9
	Compliance of this power supply with FCC Part 15, Class B with a standard output load. The FCC law stipulates that systems are required to demonstrate compliance with the FCC emission system load.
 L00599A	Hong Kong Safety Mark License IEC62368-1:2018

Delivering leading edge, innovative power solutions for more than 30 years....

Model:GTM961800PWWWVV.V-T3







September 29, 2022

	<p>INDIA BIS (GTM961800P-T3) 12,13.5,15,18,19,24,30,36,4</p>
	<p>Indoor Use Only - Mark is on the label or Molded in the case</p>
<p>IP41</p>	<p>Ingress Protection: ?IP41 to IEC60529:2001 Protection against granular foreign bodies - Protected against vertically falling</p>
 <p>DC-E-G71-007.1</p> <p>PRECAUCION: PARA USO EN EQUIPOS ELECTRONICOS SOLAMENTE</p>	<p>IRAM certificate DC-E-G71-007.1 to IEC 62368-1:2014</p>
 <p>GlobTek, Inc.</p>	<p>JAPAN TUV R-PSE, Cert. No. JD 50469658, to J62368-1(J55032(H29),J3000(H25)[15V or less]. Please reference the guidelines on PSE regulations: http://en.globtek.com/importing-ite-and-medical-power-sup</p>
	<p>Korea for GTM961800P16012-T3(A) (12-13.5V)</p>

Delivering leading edge, innovative power solutions for more than **30** years....

Model:GTM961800PWWWV.V-T3





September 29, 2022

 직류전원장치 AC/DC ADAPTER KTC HU10499-21049A R-R-GSZ-0012 전기용품안전관리법에 의한 표시 모델명:GTM961800P18024-T3 <hr/> Mfr. Name: GLOBTEK (SUZHOU) CO.,LTD A/S Center:10-6221-6100	Korea KET KC Mark GTM961800P18024-T3 HU10499-21
EFFICIENCY LEVEL 	Efficiency: complies to section 301 of Energy Independence complies with Energy Star tier 2 (North America), ECP tier (Australia), Code of Conduct (Europe)
	Morocco SDoC declaration http://www.globtek.info/certs/Morocco%20SDoC%20Decla
	NOM MEXICO NYCE for GTM961800P16012-T3 (12V on
	RCM certificate SAA-200456-EA; Australia and New Zeala Compliance, Mark (http://rcm.standards.org.au/rcmfaq/rcm
RoHS	Specifications of directive 2011/65/EU Annex VI (ROHS-2) 2015/863-EU (ROHS-3) http://www.ce-mark.com/Rohs%2
	EN 60601-1:2006 + A1:2013 + A12:2014 EN 60601-1-11:2015
	S-Mark Certificate EN 60950-1:2006 + A11:2009 + A1:201 http://www.intertek.com/marks/s/
إمدادات الطاقة	Saudi Arabia approval GTM961800P-T3 IEC 60950-2005 (pending)

Delivering leading edge, innovative power solutions for more than **30** years....

Model:GTM961800PWWWVV.V-T3

September 29, 2022

	Singapore to IEC 62368 (for 12V only)
	UKCA Certification
	Ukraine UKRSepra (Document: www.globtek.com/html/iso_certificates/GT_Ukraine.pdf)
	Japan: Voluntary Control Council for Interference (VCCI)
	WEEE: Complies with EU 2012/19/EU (http://ec.europa.eu/environment/waste/weee/index_en.htm) Mark is on the label or Molded in the case