

Delivering leading edge, innovative power solutions for more than 30 years....

Model:GT-46120-12VV-x.x-Q

September 29, 2022

## DOE EPS 2.0 Level VI Power Supply / Charger / AC Adapter, 12W, Available with 5-24VDC output Certified to Medical and ITE Standards

### Information

Model Number	GT-46120-12VV-x.x-Q
Description	GT-46120-12VV-x.x-Q, ICT/ITE Power Supply, Wall Plug-in, Regulated Switchmode AC-DC Power Supply AC Adaptor, , Input Rating: 100-240V~, 50-60 Hz, Blade Options for Q Series Wall Plug-in Power Supplies, Output Rating: 12 Watts, Power rating with convection cooling (W) , 5-48V in 0.1V increments, Approvals: 230V CoC Tier 2; EAC; UL-CUL; CB 62368; LPS 62368; cULus; Morocco; CE; China RoHS; Double Insulation; Level VI; PSE; RoHS; Ukraine; VCCI; WEEE;

### Model Picture



Agency Documents	<a href="http://www.globtek.info/certs/GT-46120-WVVV/">http://www.globtek.info/certs/GT-46120-WVVV/</a>
CE EC-Declaration	<a href="https://www.globtek.com/pdf/ec_declaration/a00a000000Nrw14EAB">https://www.globtek.com/pdf/ec_declaration/a00a000000Nrw14EAB</a>
RoHS/RoHS2 Declaration	<a href="https://www.globtek.com/pdf/rohs_cert/a00a000000Nrw14EAB">https://www.globtek.com/pdf/rohs_cert/a00a000000Nrw14EAB</a>
REACH Declaration	<a href="https://www.globtek.com/pdf/iso_certificates/REACH.pdf">https://www.globtek.com/pdf/iso_certificates/REACH.pdf</a>
Conflict Minerals Declaration	<a href="https://www.globtek.com/pdf/conflict-minerals.pdf">https://www.globtek.com/pdf/conflict-minerals.pdf</a>

Delivering leading edge, innovative power solutions for more than **30** years....

Model:GT-46120-12VV-x.x-Q

September 29, 2022

**MODEL PARAMETERS**

Type	Wall Plug-in
Technology	Regulated Switchmode AC-DC Power Supply AC Adaptor
Category	ICT/ITE Power Supply
Input Voltage	100-240V~, 50-60 Hz
I/P Amps (A)	0.6A
Wattage (W)	12.0
Vout Range (V)	5-48
Efficiency Level	USA DOE Level VI / Eco-design Directive 2009/125/EC, (EU) 2019/1782
Ingress Protection	IP52
Size (mm)	64.0*40.5*31.5

Delivering leading edge, innovative power solutions for more than **30** years....

Model:GT-46120-12VV-x.x-Q

September 29, 2022

## ENCLOSURE

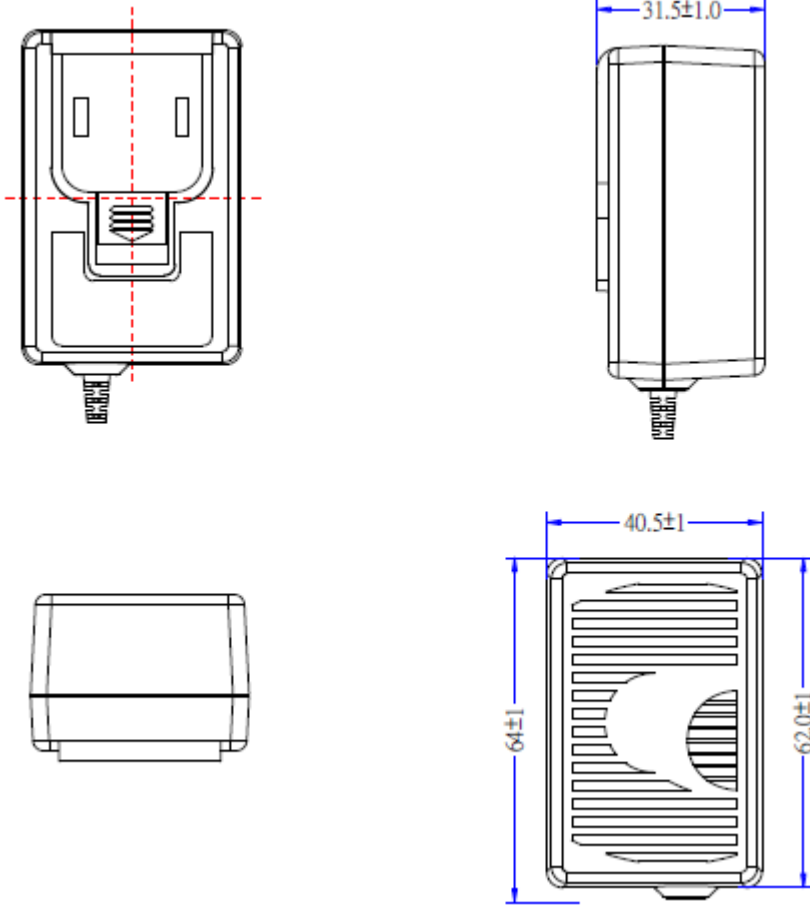

Delivering leading edge, innovative power solutions for more than **30** years....

Model:GT-46120-12VV-x.x-Q

September 29, 2022

**RATING TABLE**

Model Number	Voltage	Amps(A)	Watts(W)	RFQ
GT-46120-1005	5 V	2	10.00	<a href="#">RFQ</a>
GT-46120-1206-0.05	5.95 V	2	11.90	<a href="#">RFQ</a>
GT-46120-1212-4.5	7.5 V	1.33	9.98	<a href="#">RFQ</a>
GT-46120-1212-3.0	9 V	1.33	11.97	<a href="#">RFQ</a>
GT-46120-1212	12 V	1	12.00	<a href="#">RFQ</a>
GT-46120-1224-9.0	15 V	0.8	12.00	<a href="#">RFQ</a>
GT-46120-1215	15 V	0.8	12.00	<a href="#">RFQ</a>
GT-46120-1224-4.0	20 V	0.6	12.00	<a href="#">RFQ</a>
GT-46120-1224	24 V	0.5	12.00	<a href="#">RFQ</a>
GT-46120-1248	48 V	0.25	12.00	<a href="#">RFQ</a>

## SPECIFICATIONS

### A) ELECTRICAL SPECIFICATIONS:

01. Input Voltage: Specified 90-264 Vac, Nameplate rated: 100-240Vac
02. Input Frequency: Specified 47-63 Hz, Nameplate rated 50-60Hz
03. Output Regulation: +/- 5% measured at the output connector
04. Line Voltage Regulation: +/- 1% typical measured at the output connector
05. Average Efficiency: 82.96% Min (CEC & DOE LEVEL VI Compliant); 83.26% Min (ErP European Commission's Ecodesign Directive (2005/32/EC) / CoC Tier 2 Compliant)
06. Input Power(no load): <0.1W (CEC &DOE Level VI Compliant); <0.075W ErP European Commission's Ecodesign Directive (2005/32/EC) / CoC Tier 2 Compliant)
07. Output Ripple (Vp-p): +/-1% or 150 mV whichever is greater, measured at 20 MHz bandwidth with 0.1 uf ceramic capacitor in parallel with 10 uf electrolytic capacitor connected at the end of the output connector at nominal line
08. Turn-ON/OFF Overshoot: 5% maximum, 1 mS typical recovery time for 25% step load
09. Turn-ON Delay: 1 Sec,typical
10. Hold-Up Time: 8 mS typical at nominal input voltage and full load
11. Inrush Current: 30A typical at 115VAC input ; 60A typical at 230VAC input
12. Switching Frequency: 65 KHz typical

### B) PROTECTION

01. Over-Voltage: Protected Zener clamp across the output
02. Short Circuit: Protected unit will auto recover upon removal of fault
03. Input Protection: Input line fusing

### C) SAFETY

01. Dielectric Withstand Voltage: 4242Vdc from primary to secondary
02. Touch Current: <0.25mA @ 240Vac input voltage

### D) EMC

01. Emissions, per EN 55032, EN 61000-6-3, EN 61000-6-4
  - Conducted Emissions: Class B, FCC Part 15, Class B
  - Radiated Emissions: Class B, FCC Part 15, Class B
02. Line Frequency Harmonics EN61000-3-2, Class A
03. Voltage Fluctuations/Flicker EN61000-3-3
04. Immunity, per EN 55024, EN 61000-6-1, EN 61000-6-2
  - Static Discharge Immunity EN61000-4-2, 4kV Contact Discharge, 8kV air discharge
  - Radiated RF Immunity EN61000-4-3, 3V/m 80-1000MHz, 80% 1KHz AM.
  - EFT/Burst Immunity EN61000-4-4, 1kV/100kHz.
  - Line Surge Immunity EN61000-4-5, 1kV differential, 2kV common-mode
  - Conducted RF Immunity EN61000-4-6, 3Vrms, 80% 1KHz AM
  - Power Frequency Magnetic Field Immunity EN61000-4-8, 1A/m
  - Voltage Dip Immunity EN61000-4-11, Criteria

### E) OTHER:

01. MTBF: 200,000 Hours @ 25°C ambient temperature
02. Operating Temperature: 0°C to 40°C ambient temperature

Delivering leading edge, innovative power solutions for more than **30** years....

Model:GT-46120-12VV-x.x-Q

September 29, 2022

- 03. Humidity: 0% to 90% relative humidity
- 04. Storage Temperature: -10°C to 80°C
- 05. Cooling: Convection

**F) ENCLOSURE**

- 01. Housing: High impact plastic, 94V0 polycarbonate, non-vented
  - 02. Size: 64.0\*40.5\*31.5 +/-1.0 mm
  - 03. Markings: Label and/or Pad Printed and/or Molded in the case
-

Delivering leading edge, innovative power solutions for more than 30 years....

Model:GT-46120-12VV-x.x-Q

September 29, 2022

## DERATING CURVE

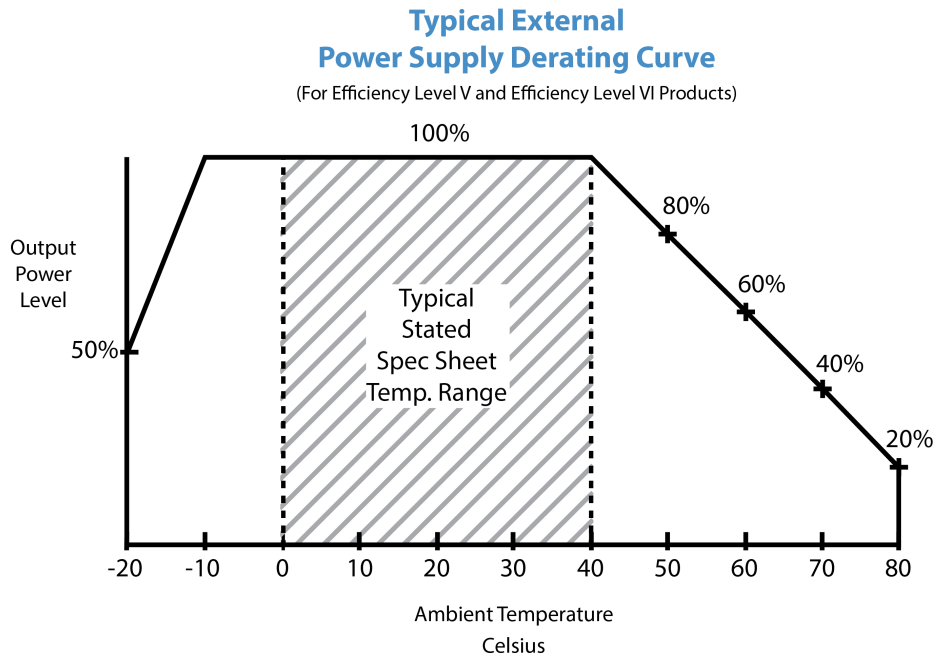

Delivering leading edge, innovative power solutions for more than 30 years....

Model:GT-46120-12VV-x.x-Q

September 29, 2022

**INPUT CONFIGURATION**

Description Blade Options for Q Series Wall Plug-in Power Supplies

 Data Sheet: <http://en.globtek.com/interchangeable-blades.php>

 Insertion Instructions: <http://www.globtek.com/pdf/Instructions-Interchangeable-Blades.pdf>

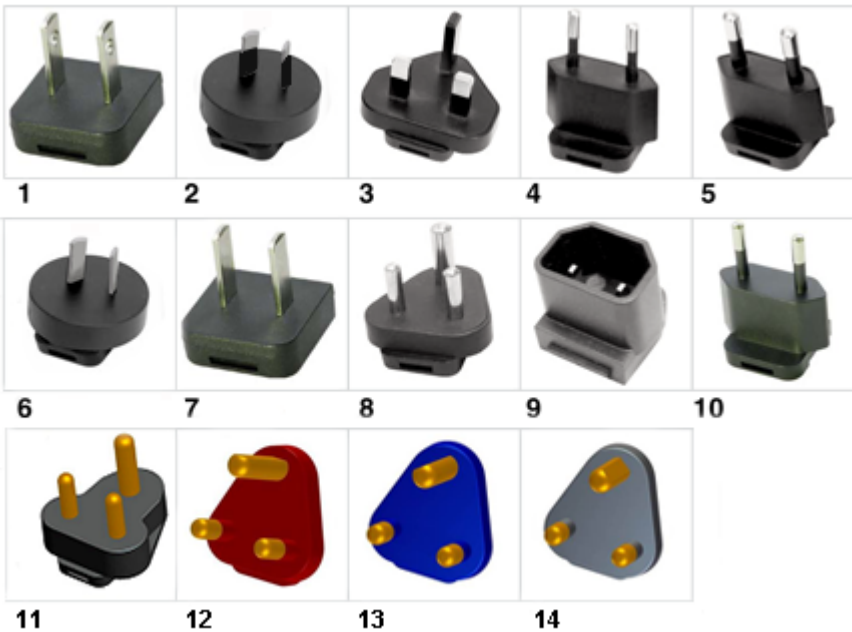
 Video: [Q-Blade Style Instruction Video](#)

INPUT CONNECTOR: Q-Socket (below are available blades configurations which are "not included" (unless stated above); can be purchased separately, package with power supply or as a separate "Q-KIT" if specified

01. United States / Canada / Japan NEMA 1-15P/ IEC PLUG Type A [WORKS IN PLUG B] configuration: NA 2 blades, Class II; US/CA/JP P/N: Q-NA(R)
02. Australian AS 3112 configuration: SAA 2 blade/ IEC TYPE I, Class II; AU P/N: Q-SAA(R)
03. UK BS 1363 configuration: UK 3 blade with dummy Ground/ IEC TYPE G, Class II; GB P/N: Q-UK(R)
04. European CEE 7/16 configuration: Europlug 2 pins/ IEC TYPE C [WORKS IN TYPE E&F], Class II; EU P/N: Q-EU(R)
05. Korean KS C8305 configuration: 2 pins/SIMILAR TO IEC TYPE C, Class II; KR P/N: Q-KR(R)
06. Argentina IRAM 2073 configuration: 2 blades/SIMILAR TO IEC TYPE I; AR P/N: Class II Q-AR(R)
07. China GB 2099 configuration: 2 blades/SIMILAR TO TYPE A, Class II; CN P/N:Q-CN(R)
08. India IS 1293 6A/BS546 configuration: 5A, 3 pins with Dummy Ground, Class II/IEC TYPE D; IN P/N: Q-IN(R)
09. IEC60320/C18 Inlet, Class II; P/N: Q-C18(R)
10. Brazilian NBR6147 configuration: 2 pins, Class II;SIMILAR TO IEC TYPE C BR P/N: Q-BR(R)
11. South Africa SABS164-1 and India IS 1293, IS694, 16A type plug, 3 round prongs, Class II + dummy ground, IEC TYPE M P/N: Q-SANS164-1-16A(R)
12. South Africa SABS164-4, 3 round prongs with a notched prong @ 0°, Class II + dummy ground, IEC TYPE M Red, P/N: Q-SANS164-4C-16A(R)

**PROPRIETARY INFORMATION**

PROPRIETARY OF GLOBTEK, INC. ANY REPRODUCTION, DISCLOSURE OR USE OF THIS DRAWING, IN WHOLE OR IN PART, IS HEREBY PROHIBITED EXCEPT AS SPECIFIED IN WRITING BY GLOBTEK, INC.

<https://www.globtek.com/datasheet/w71133>



Delivering leading edge, innovative power solutions for more than **30** years....

Model:GT-46120-12VV-x.x-Q

September 29, 2022

13. South Africa SABS164-4, 3 round prongs with a notched prong @ -53°, Class II + dummy ground, Blue, IEC TYPE M,  
P/N:

Q-SANS164-4L-16A(R)

14. South Africa SABS164-4, 3 round prongs with a notched prong @ +53°, Class II + dummy ground, Black,IEC TYPE M  
P/N:

Q-SANS164-4R-16A(R)

**Kits**

01. Q-KIT: 1,2,3,4 above

02. Q-KIT-INTL: 2,3,4 above

03. Q-KIT-6: 1,2,3,4,5,6 above

04. Q-KIT-7: 1,2,3,4,5,6,7 above

05. Q-KIT-8: 1,2,3,4,5,6,7,8 above

Delivering leading edge, innovative power solutions for more than 30 years....

Model:GT-46120-12VV-x.x-Q

September 29, 2022

**OUTPUT CONFIGURATION**

Common output connector options:

 L Type (Coaxial  
5.5x2.5mm plug)

 C Type (Coaxial  
5.5x2.1mm plug)

 K Type (Coaxial  
3.5x1.3mm plug)

 LL Type (5.5x2.5mm  
Locking 760k type)

 CL Type (5.5x2.1mm  
Locking S761k type)

 ML2 Type (Molex  
housing 43025-0200)

 YL3 Type  
(KPPX-3P)

YL4 Type (KPPX-4P)

 EJ1/2/3/4/5 (EIAJ  
RC-5320A type  
connectors)

 MSB Type (Micro  
USB)

 USBC Type (USB  
Type C)

 Inquire for custom  
design

 For a comprehensive list of options, [click here](#)

Contact GlobTek for your specific requirements or custom solutions.

Delivering leading edge, innovative power solutions for more than **30** years....

Model:GT-46120-12VV-x.x-Q

September 29, 2022







## Approvals

Logo	Description
No Logo Applicable	EU 230V CoC Tier 2, 278/2009, Mar 2014
No Logo Applicable	CB for IEC 62368-1:2014 (Second Edition) + A11:2017
	CE Certification
	CHINA SJ/T 11364-2014, China RoHS Chart: <a href="http://en.globtek.com/globtek-rohs.php">http://en.globtek.com/globtek-rohs.php</a>
Conforms to UL STD. 62368-1 Certified to CSA STD C22.2 NO.62368-1	Conforms to UL STD. 62368-1 Certified to CSA STD C22.2 NO.62368-1
	
	Declaration ДС № EAЭC N RU Д-US.KA01.B.10453_19 Custom Union of Russia, Belarus and Kazakhstan <a href="http://www.globtek.com/redirect/?loc=gost-certificate-eac-declaration">http://www.globtek.com/redirect/?loc=gost-certificate-eac-declaration</a>
	Indoor Use Only - Mark is on the label or Molded in the case
EFFICIENCY LEVEL 	Efficiency: complies to section 301 of Energy Independence and Security Act (EISA) complies with Energy Star tier 2 (North America), ECP tier 2 (China), MEPS tier 2 (Australia), Code of Conduct (Europe)
LPS	Limited Power Source 62368
	Morocco SDoC declaration <a href="http://www.globtek.info/certs/Morocco%20SDoC%20Declaration/">http://www.globtek.info/certs/Morocco%20SDoC%20Declaration/</a>

Delivering leading edge, innovative power solutions for more than **30** years....

Model:GT-46120-12VV-x.x-Q

September 29, 2022

 GlobTek, Inc.	JAPAN TUV Rheinland-PSE GlobTek Inc to J60950-1(H26) , J55022(H22),J3000(H25).Please follow the procedure listed in the following link for proper import to Japan: <a href="http://en.globtek.com/importing-to-japan.php">http://en.globtek.com/importing-to-japan.php</a> .
RoHS	Specifications of directive 2011/65/EU Annex VI (ROHS-2) with amendment 2015/863-EU (ROHS-3) <a href="http://www.ce-mark.com/Rohs%20final.pdf">http://www.ce-mark.com/Rohs%20final.pdf</a>
	UKCA Certification
 1Q276	Ukraine UKRSepr (Document: <a href="http://www.globtek.com/html/iso_certificates/GT_Ukraine.pdf">www.globtek.com/html/iso_certificates/GT_Ukraine.pdf</a> )
	UL 62368-1 and CAN/CSA C22.2 No. 62368-1-14
 UL 817 <a href="#">LINK TO CERT</a>	UL/CUL
	Japan: Voluntary Control Council for Interference (VCCI)
	WEEE: Complies with EU 2012/19/EU ( <a href="http://ec.europa.eu/environment/waste/weee/index_en.htm">http://ec.europa.eu/environment/waste/weee/index_en.htm</a> ) Mark is on the label or Molded in the case